

- OPTIONS:
DRILL ONE SIDE ONLY (DOSO)
NO DRILLING
NO KICKPLATE BRACKET (STD)
KICKPLATE BRACKET W/O HOLES
KICKPLATE BRACKET W/- HOLES

P STANCHION

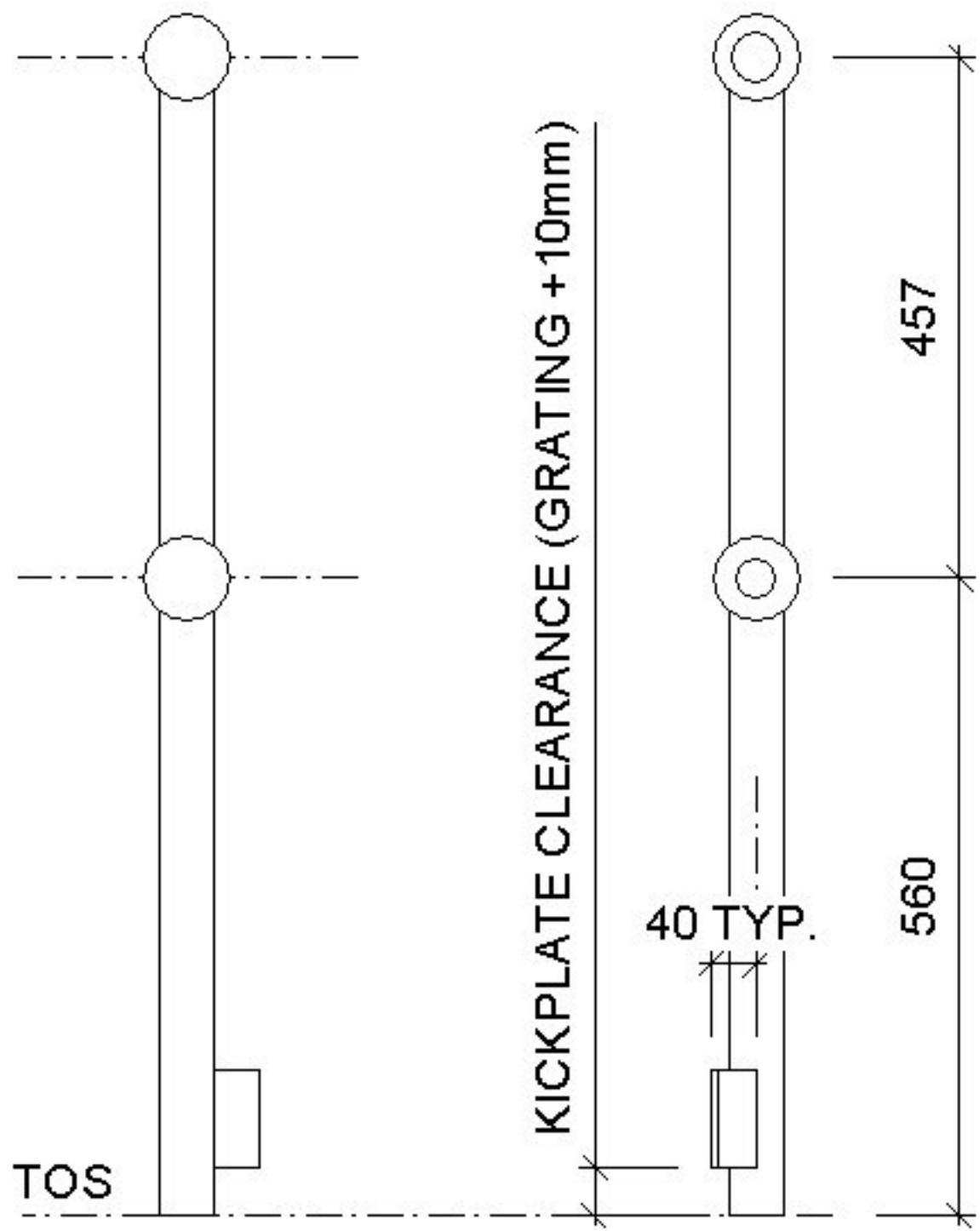
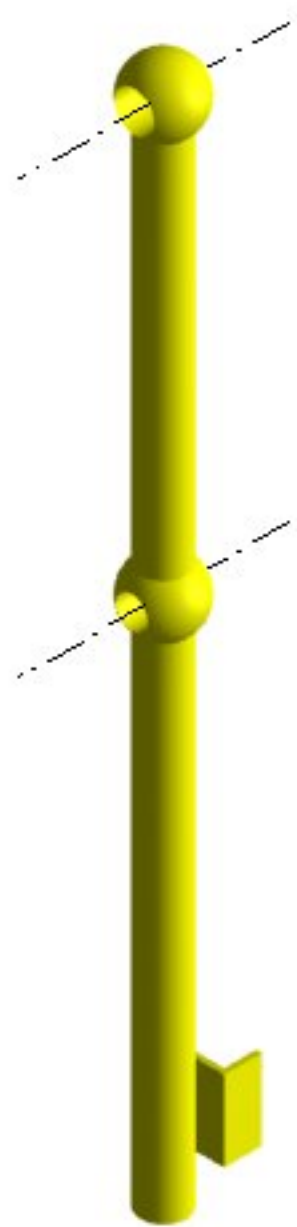

- OPTIONS:
DRILL ONE SIDE ONLY (DOSO)
NO DRILLING
NO KICKPLATE BRACKET (STD)
KICKPLATE BRACKET W/O HOLES
KICKPLATE BRACKET W/- HOLES

W STANCHION

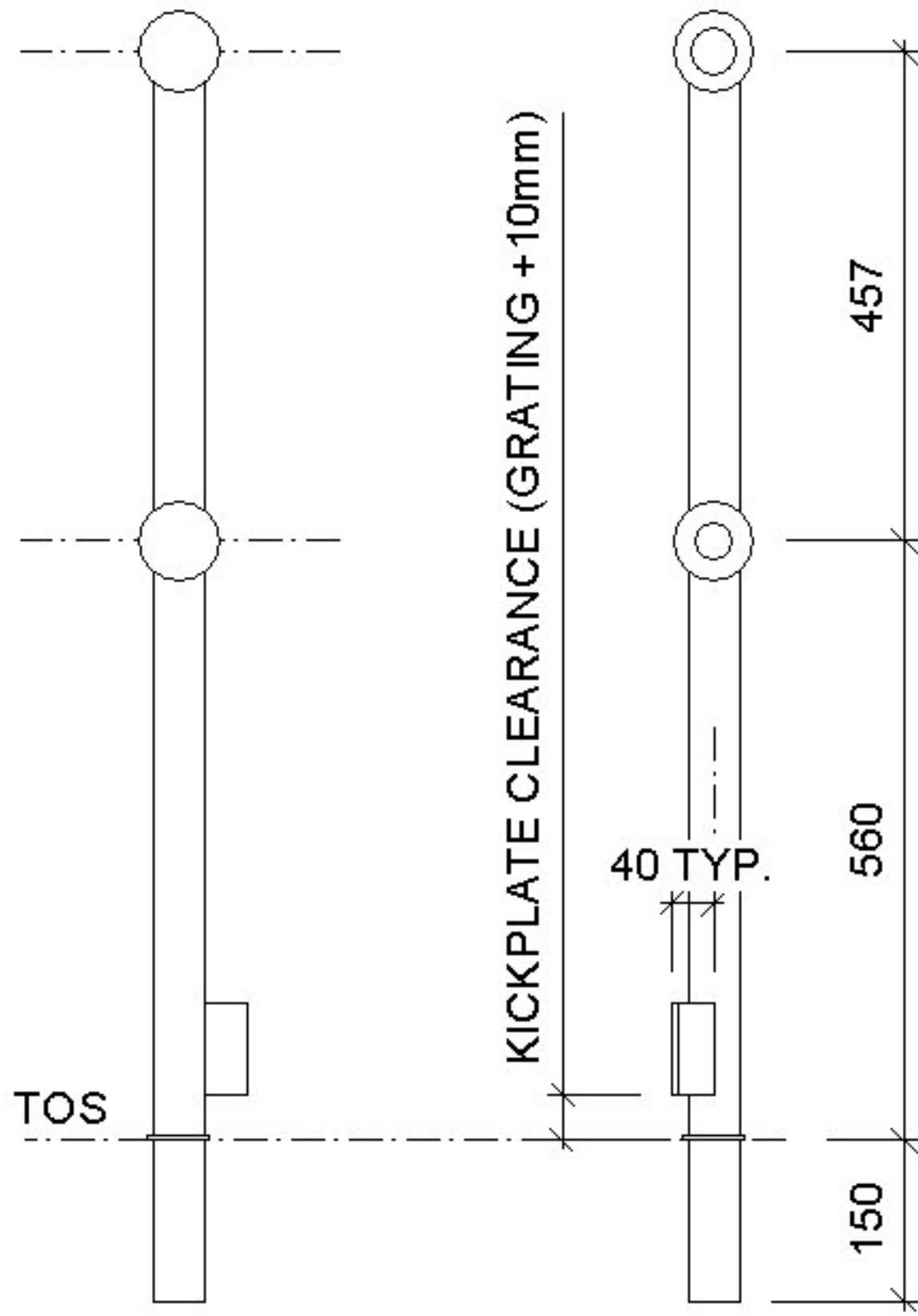
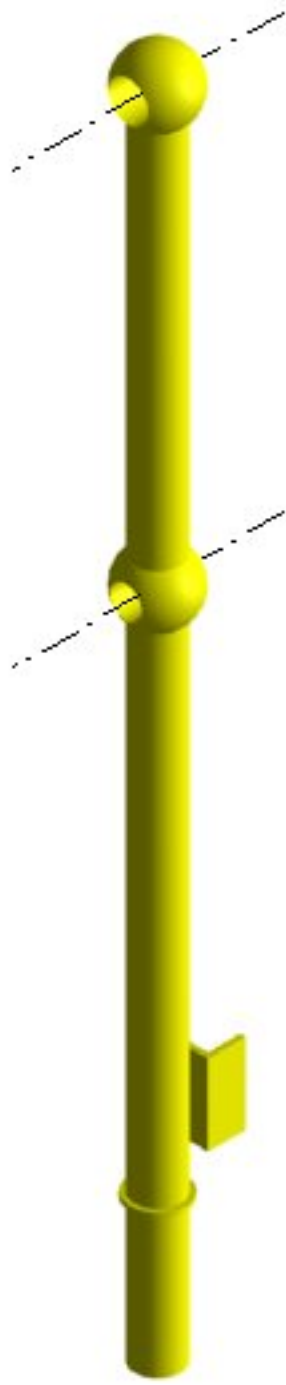

OPTIONS:
DRILL ONE SIDE ONLY (DOSO)
NO DRILLING
NO KICKPLATE BRACKET (STD)
KICKPLATE BRACKET W/O HOLES
KICKPLATE BRACKET W/- HOLES

C STANCHION

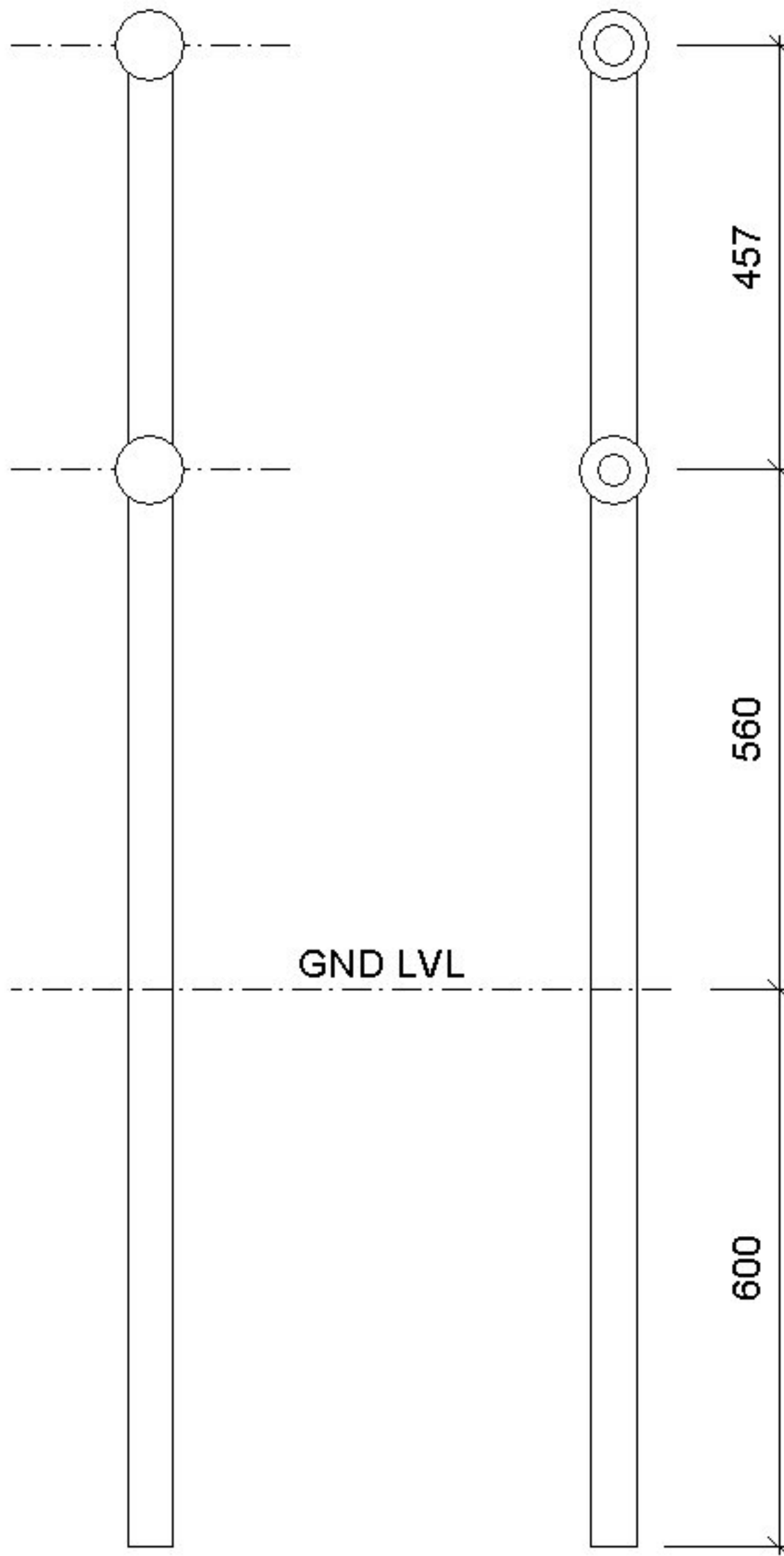

OPTIONS:
DRILL ONE SIDE ONLY (DOSO)
NO DRILLING
NO KICKPLATE BRACKET (STD)
KICKPLATE BRACKET W/O HOLES
KICKPLATE BRACKET W/- HOLES

IG STANCHION

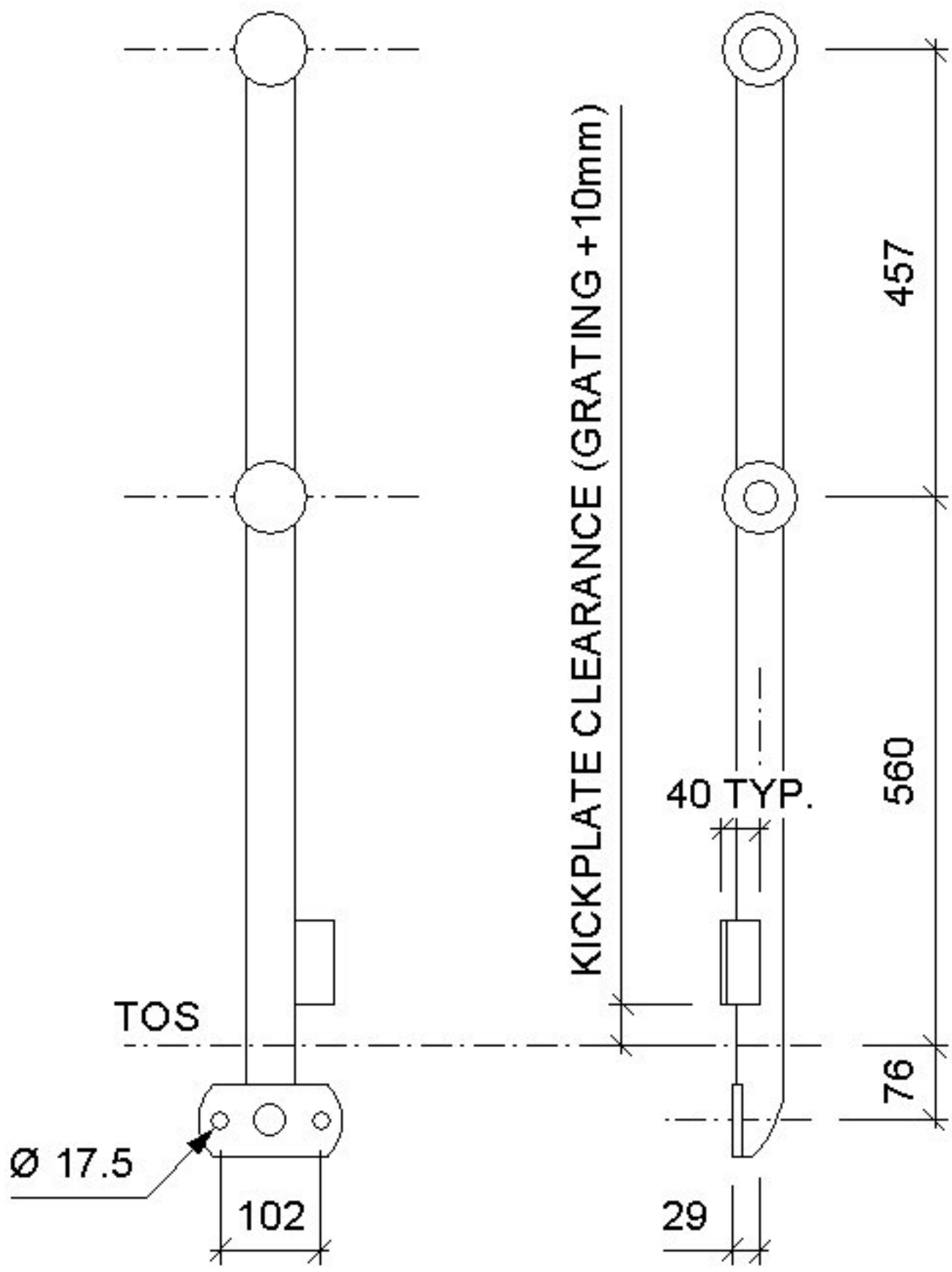
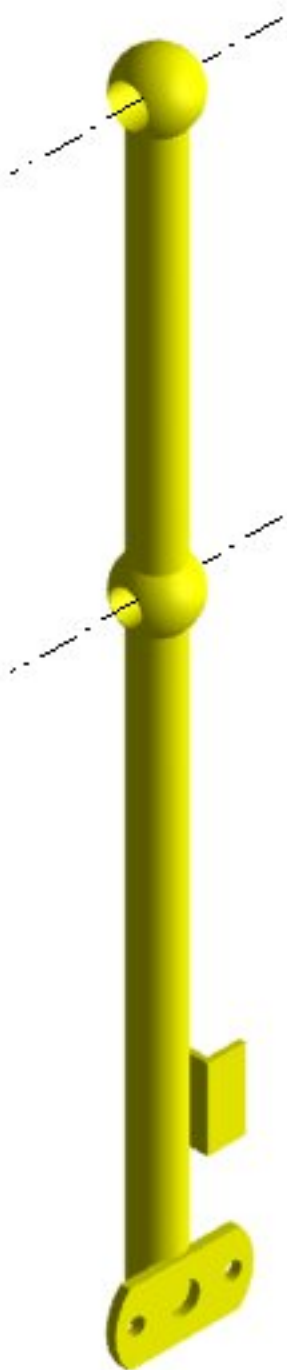

- OPTIONS:
DRILL ONE SIDE ONLY (DOSO)
NO DRILLING
NO KICKPLATE BRACKET (STD)
KICKPLATE BRACKET W/O HOLES
KICKPLATE BRACKET W/- HOLES

S STANCHION



SAL
(1° - 45°)



SAR
(1° - 45°)

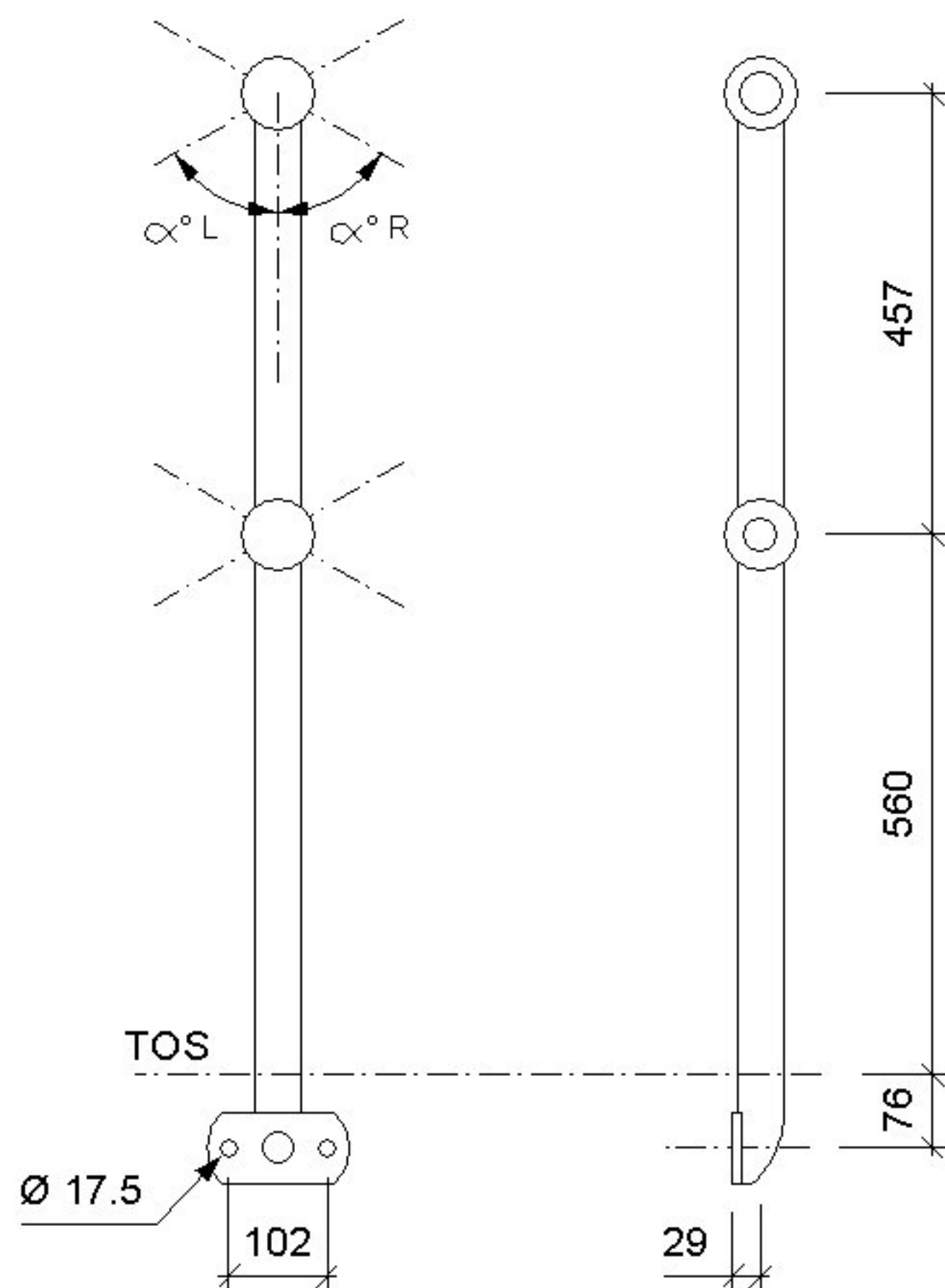

SA STANCHION

OPTIONS:
DRILL ONE SIDE ONLY (DOSO)
NO DRILLING